

i3HUDDLE





i3HUDDLE

USER MANUAL

75"

Please read this guide carefully before operating your set and retain it for future reference.



CAUTION!

- Changes or modifications not expressly approved by the party responsible for compliance could void the user's authority to operate the equipment.
- This User Guide includes detailed usage instructions for your product. Please read this manual thoroughly.
- Figures and illustrations in this User Manual are provided for reference only and may differ from actual equipment appearance. Equipment design and specifications may be changed without notice.



Getting Started

Contents

Safety Information	3
Unique features, Accessories	7
Components	8
Installation Guide	9
Connections	10
Remote Controller	11
Power on/off	12
Android Screen	13
Touch On Screen Display(OSD)	14
IFTD Settings in Android	15
External Devices and Touch Functions	16
Network, Update & Language Settings.....	17
Specification	18



Important Safety Instructions

The illustrations may differ slightly from the items shipped with your product.

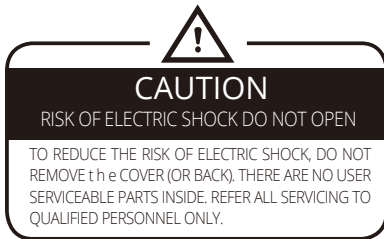

The slots and openings in the product are provided for necessary ventilation. To ensure reliable operation of this product, and to protect it from overheating, these slots and openings must never be blocked or covered.

Do not cover the slots and openings with a cloth or other materials.

Do not block the slots and openings by placing this product on a bed, sofa, rug or other similar surface.

Do not place this product in a confined space, such as a bookcase, or built-in cabinet, unless proper ventilation is provided.

Do not place this product near or over a radiator or heat resistor, or where it is exposed to direct sunlight.

Do not place heat generating items such as candles, ashtrays, incense, flammable gas or explosive materials near this product.

Do not place a water containing vessel on this product, as this can result in a risk of fire or electric shock.

GETTING STARTED

Do not expose this product to rain or place it near water or in a wet environment (near a bathtub, washbowl, kitchen sink, or laundry tub, in a wet basement, or near a swimming pool etc.). If this product accidentally gets wet, unplug it and contact an authorized dealer immediately.

This product uses batteries. In your community there might be regulations that require you to dispose of these batteries properly under environmental legislations. Please contact your local authorities for disposal or recycling information.

Do not exceed the standard capacity of a multi-plug or power outlet extension when using it for this product. There is a danger of an electric shock or a fire hazard.

To protect this apparatus from a lightning storm, or when it is left unattended and unused for long periods of time, unplug it from the electric outlet. This will prevent damage to the set due to lightning and/or power line surges.

Use your common sense when operating this product. Never insert anything metallic into the open parts of this product. Doing so may result in an electric shock and/or serious injury.

To avoid electric shock, never touch the inside of this product. Only a qualified technician should open this product. If there is a fault with this product do not attempt to fix it yourself; unless you are a qualified technician.

Do not touch the power cord with wet hands. There is a danger of an electric shock.

Plug the power cord firmly into the power outlet. Failure to do so may cause a fire hazard.

Do not unplug the power cord by pulling the cable only. If the cord is damaged, it may cause an electric shock.

If this product does not operate normally - in particular, if there are any unusual sounds or smells coming from it - unplug it immediately and contact an authorized dealer or service center.

Be sure to pull the power plug out of the outlet if the product is to remain unused or if you are to leave the product for an extended period of time. Accumulated dust can cause an electric shock, an electric leakage or a fire by causing the power cord to generate sparks and heat or the insulation to deteriorate.

GETTING STARTED

Be sure to contact an authorized service center, when installing your product in a location with heavy dust, high or low temperatures, high humidity, chemical substances and where it operates continuously for 24 hours such as an airport, a train station etc. Failure to do so may cause serious damage to your product.

Do not allow children to hang off the product or climb onto it. If it is mounted on a stand or onto a wall the extra weight may cause the product to tip or fall.

Store the accessories (battery, bolts, screws etc.) in a location safely out of the reach of children.

Do not install the product in an unstable location such as on a weak wall, a slanted floor or a location exposed to vibrations. If this product is to be mounted onto a wall, first check that the wall can hold the weight of the product safely.

Do not drop or impart any shock to the product. If the product is damaged, disconnect the power cord and contact a service center immediately.

As a precautionary measure please make sure that you pull out the power cord from the outlet before cleaning the product.

Please take a common sense approach to installing and operating this product.

GETTING STARTED

FCC Information to Users

This equipment has been tested and found to comply with the limits for a Class B digital device, pursuant to Part 15 of the FCC Rules. These limits are designed to provide reasonable protection against harmful interference in a residential installation. This equipment generates, uses and can radiate radio frequency energy and, if not installed and used in accordance with the instructions, may cause harmful interference to radio communications. However, there is no guarantee that interference will not occur in a particular installation. If this equipment does cause harmful interference to radio or television reception, which can be determined by turning the equipment off and on, the user is encouraged to try to correct the interference by one of the following measures:

- Reorient or relocate the receiving antenna.
- Increase the separation between the equipment and receiver.
- Connect the equipment into an outlet on a circuit different from that to which the receiver is connected.
- Consult the dealer or an experienced radio/TV technician for help.

Caution

Modifications not expressly approved by the party responsible for compliance could void the user's authority to operate the equipment.

FCC Compliance Information : This device complies with Part 15 of the FCC Rules. Operation is subject to the following two conditions: (1) This device may not cause harmful interference, and (2) this device must accept any interference received, including interference that may cause undesired operation.

IMPORTANT NOTE:

FCC RF Radiation Exposure Statement:

This equipment complies with FCC RF radiation exposure limits set forth for an uncontrolled environment. This equipment should be installed and operated with a minimum distance of 20 centimeters between the radiator and your body. This transmitter must not be co-located or operated in conjunction with any other antenna or transmitter.

GETTING STARTED

Unique features

- 1) UHD LED Display
- 2) HDMI 2.0 / Display Port
- 3) Touch Sensor : PCAP
- 4) Full Touch OSD
- 5) HOME Button
- 6) Dual OS Support : Windows (Via OPS) and HUDDLE LAUNCHER (Main)

Accessories



AC Power Cable

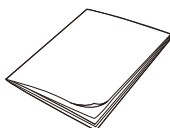

Quick Manual

Stylus * 2

i3 Charging Cradle

i3 Sync Touch Transmitter* 2

PEN Holder

GETTING STARTED

Introduction

Symbols used in this manual

Note
Indicates special notes and operating features.

Caution
Indicates cautions for preventing possible damage from abuse or mistreatment of the product.

Components

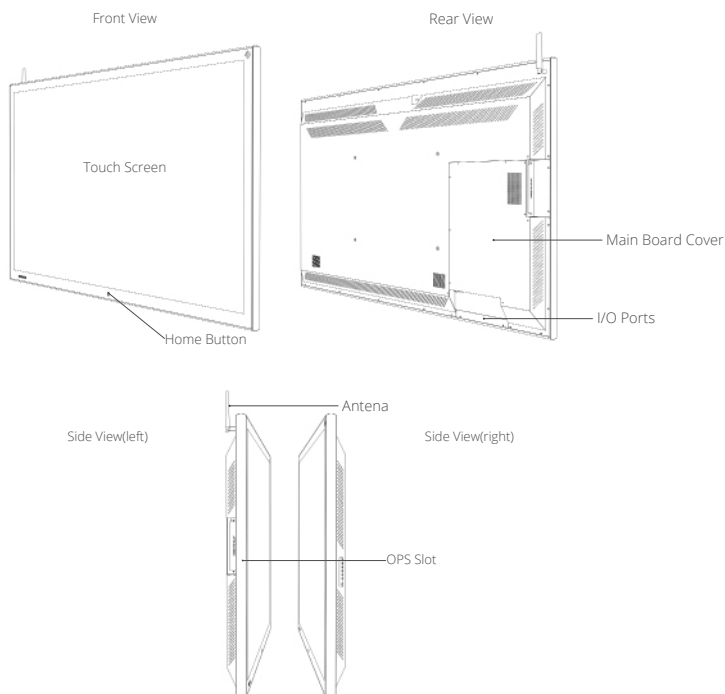

GETTING STARTED

Installation Guide

Step 1

Install the wall mount brackets on to the wall.

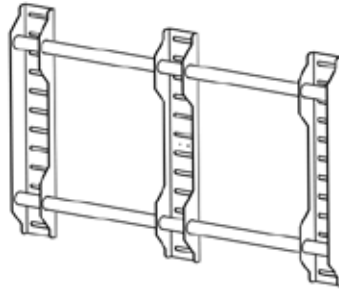
**Step 2**

Install the wing brackets on the back of the product. (Use 4 x M8 screws)

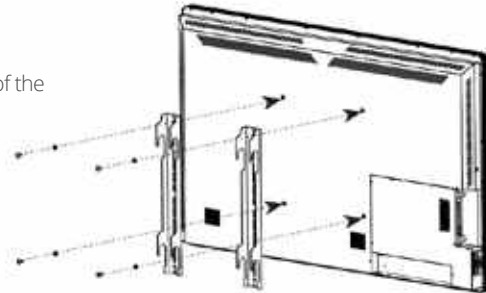
**Step 3**

Install the product as shown in the diagram.

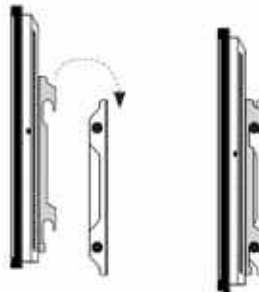

GETTING STARTED

Connections

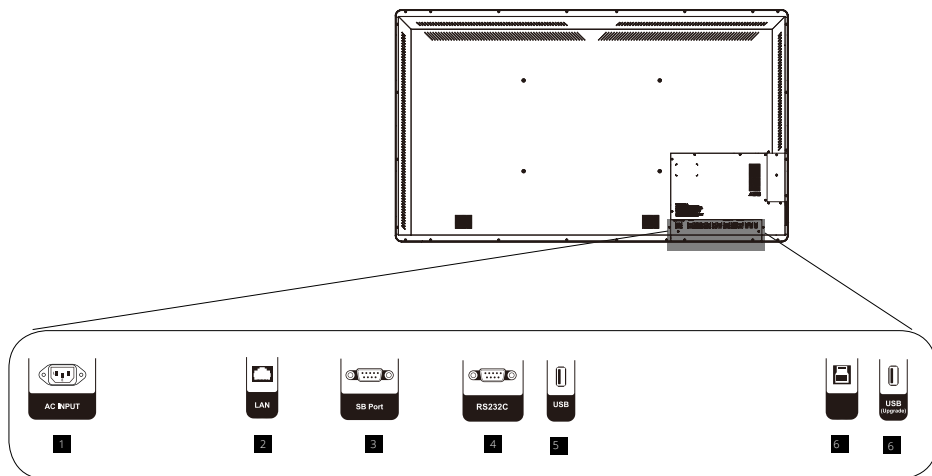

1. AC INPUT	Connect the power cable to this AC input.
2. LAN	Connect an ethernet cable for Local Area Network use.
3. SB	Connect the i3 SoundBar
4. RS232C	Connect an RS232C control device here.
5. USB	Connect USB for Media.
6. Digital Audio	Connect an Optical device to this port.
7. USB (upgrade)	Used only for upgrades.

GETTING STARTED



1. Home Key	Easy navigation : Power on -> Blue
2. LED illumination	Powered on : White
3. Antena	Wifi Antena
4. Soundbar	Mute on/off, Volume + -, Fuction

OPERATION

Power On/Off

1. Connect the AC power cable to the AC power inlet.

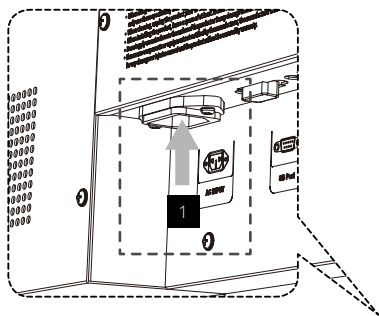

2

2. Press the Power Button

OPERATION

Home Screen

After turning on the display, the i3HUDDLE Home Screen will appear.



1. Default App

- i3NOTES: Basic Annotation app
- i3SYNC: Wireless Presenting app
- i3MEETINGHUB: Collaborating annotation app

2.Admin App

- Internet Browser app**
- Video Conference app**

3. Meeting Schedule setting

- Link to Outlook 365**

4. Public app

- 9** apps are downloadable through i3 store

5. Date and Time

6. Window

If an OPS PC is installed. User can switch to Internal PC from Home Screen

7. Exit

- Exit all running apps and downlad files.**

8. Settings

OPERATION

Settings



You can access the settings in i3HUDDLE by selecting 'settings' and found 5 settings menu

Network settings

LIVE 4 PIP shows 4 input sources in one screen at the same time. Touch one of the input source screens to change to that input source. Press the Home Button to finish 4 PIP and return to the previous screen.

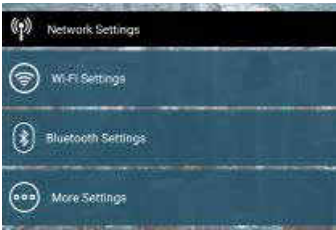

Wi-Fi Settings

1. Tap Wi-Fi
2. At the tap, tap the On/Off switch
3. On the list of available Wi-fi networks, Tap a network nam, if the network is secured and you need a password, You'll ee the Wi-Fi
4. Once you're connected

'Connected' shows under the network name.

The Wi-Fi network is a 'Saved network/' When in range, your device automatically connects to it.

TIP : While the back light unit is off, touch the screen or press the Home button to turn the back light back on again.

OPERATION

Bluetooth Settings

1. Tap Bluetooth settings
2. Tap to switch BT On or Off

More Settings

Tethering & Potable hotspot

1. Open i3HUDDLE's Settings menu
 2. Under "Network settings" tap More settings >
 3. Check the box or turn on the switch next to "Portable Wi-Fi hotspot."
- "When the option is turned on, you'll see one of the following notifications:
Portable Wi-Fi hotspot active"

Ethernet Settings

Ethernet Connections: Make sure you connect a LAN cable to the designated port in the i3HUDDLE (As shown below)

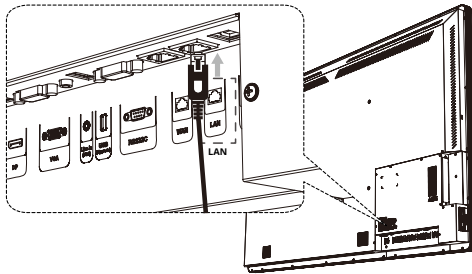

Automatically setting up the IP address by DHCP (Dynamic Host Configuration Protocol) or put the manually the IP address in Static IP setting

Display Settings



You can access the settings in i3HUDDLE by selecting 'Display settings' and found 6 settings menu

Operation

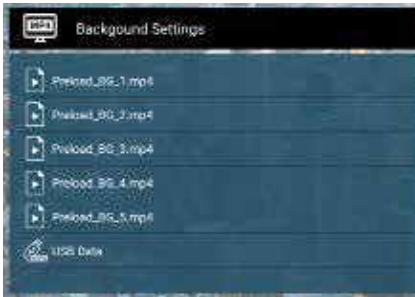

Background Video Settings

1. Tap Background Video settings
2. Select one of default mp4 files
3. Go back to home screen, background will be changed
4. You can also use your own background by USB data

Insert USB (Contain Mp4 video (less than 10mb) or image) to the designated USB ports in the back side of i3HUDDLE



Date & time Settings

You can easily set date and time on i3 Huddle. You can also choose to manual set date and time, based on network provided

time zone or select time zone by your own. To enter to the Date & Time settings, do as follows:

1. Tap Date & time settings



Operation

Language Settings

To change the language in i3HUDDLE, Select 'Language' in the display settings

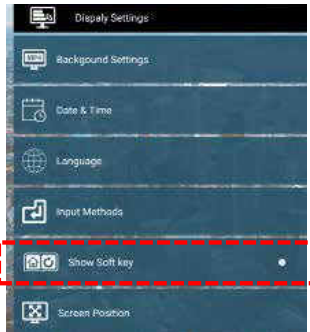

Input Methods

To change the input method in i3HUDDLE, Select 'Input Methods' in the display settings

Show Soft Key

Depends on user's preference, digital home key can be activated on the screen



Screen Position

You can adjust i3HUDDLE screen position in the display settings > Screen Positions

Server Settings

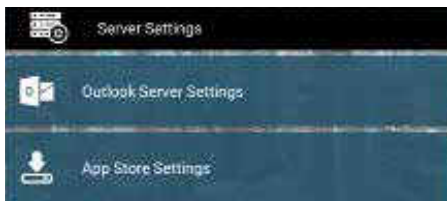

Operation



i3HUDDLE Player update

You can update i3HUDDLE Player firmware if there is new version updated.
- Make sure your network available

Reset & Password

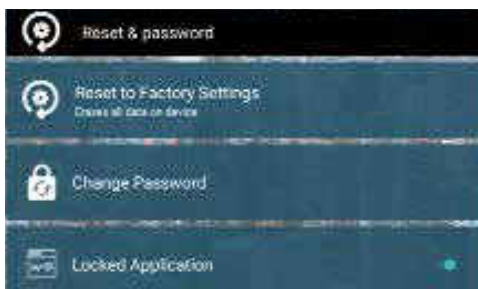

Reset to Factory settings

You can remove all data from your i3 HUDDLE device by resetting it to factory settings

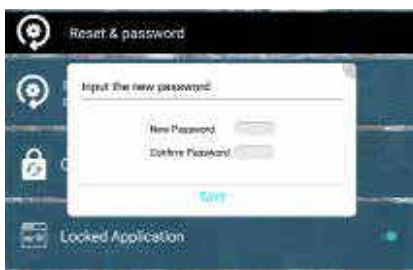

Change Password

If you want to change the password, put new password and confirm new password.

Network Settings, Software Updates & Language Options

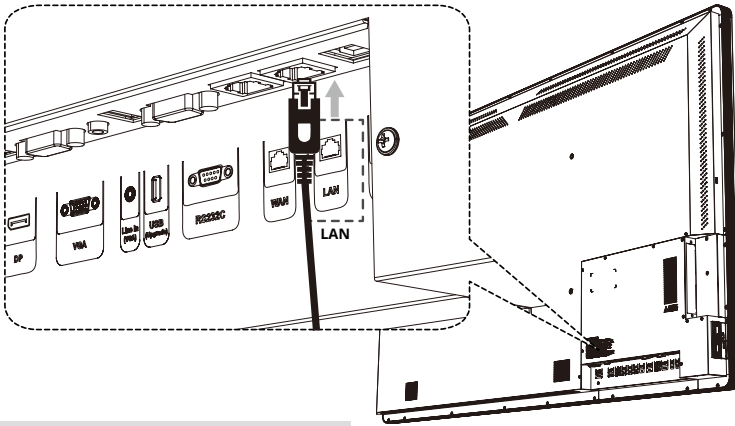

Network Settings

You can access the IFTD's Android Network Settings by selecting the 'Settings' option in the Menu & Navigation bar.

- **Ethernet Connection:** Connect a LAN cable to the designated port in the IFTD (as shown above). Ethernet connection options can then be altered in Android and Windows according to network specifications.

Software Updates

Select the 'Settings' option in the Menu & Navigation bar. Scroll down and select the 'About Device' option. In the menu bar on the right, select the 'Software Update' option. Now simply choose the method you would like to use to update the software.

Language & Input Options

To change the language and input options of the IFTD in Android, select the 'Language & Input' option in the 'Settings' menu bar. You should now be able to change the language, keyboard and input methods of the IFTD.

Appendix

Panel Information

Diagonal Size	75"
Optimal Resolution	Ultra HD 3840 * 2160@60Hz
Back Light Unit	E-Led
Response Time	8.0M/s (Typ G to G)
Viewing Angle	H:178° / V178°
Contrast Ratio	1200:1 (Typ)
Brightness	410CD/m2

Touch Information

Touch Technology	Surface Projected Capacitive Touch Module
Simultaneous Touch points	40 Points
Touch Accuracy	8ms
HDMI Cable 2.0	1
Touch Compatibility Supported OS	Windows: Win 10 Win8 Retail Version, Win7, XP* iOS*: Over Mac OS 10.9 (Mavericks) Android: 6.0 5.1 5.0, 4.0 ~ 4.4 *Limited to single-point touch
Passive Stylus Support (mm)	6 to 9 mm
Palm Rejection	40 * 40mm Large Area Rejection
Stylus Pen	-
User Guide	1

Appendix

Features

Diagonal Size	75"
Dual OS Support	Yes
Window Support	Yes(VIA OPS)
App Store Support	Yes(Via i3 Store)
Home Button	Yes
Sound bar	Yes
Wireless Presenting	Yes(i3 sync)

Accessory kit

Diagonal Size	75"
AC Power Cable	1
Passive Stylus	2
Pen Holder	1
i3 Sync Touch Transmitter	2
i3 Sync Charging Cradle	1
User Guide	1

Connection Information

Diagonal Size	75"
AC Input	1
LAN	1
SB Port	1
RX 232C	1
USB 2.0	1
Digital Audio	1
USB(Upgrade)	1

Appendix

Environmental Information

Diagonal Size	75"
Operating Temperature	0°C~40°C
Storage Temperature	-10°C~60°C
Operating Humidity	~80%
Storage Humidity	~90%

Mechanical Information

Diagonal Size	75"
Outline Dimensions	1,739mm * 80mm * 1,037.2mm
Packaged Outline Dimension	1,935mm * 295mm * 1,290mm
Product Weight	101Kg (W i3 sound bar) 95Kg (W/O i3 sound bar)
Gross Weight	115kg
Installation Type	Stand,Wall Mount
Mount Type	VESA 600mm * 400mm
Power Consumption	100 ~ 240V~
Viewing Orientation	Landscape Only
Regulatory Approval	CE, RoHS Green compliant, FCC
Warranty	2 years

Appendix

i3 Huddle Dimensions

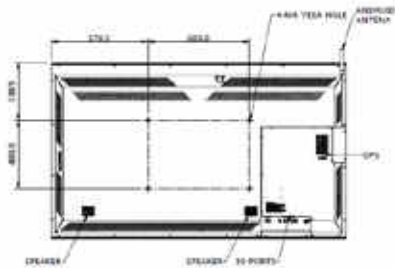
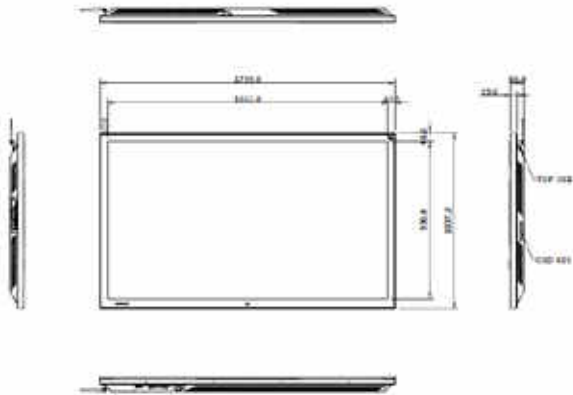



i3-TECHNOLOGIES
MEETING

Date of Purchase

www.i3huddle.com